

[CONTRIBUTION FROM THE COLOR LABORATORY OF THE U. S. BUREAU OF CHEMISTRY.]

SOME ASPECTS OF THE BEHAVIOR OF CHARCOAL WITH RESPECT TO CHLORINE.¹

BY G. S. BOHART AND E. Q. ADAMS.

Received January 8, 1920.

I. Object of Investigation.

Preliminary work on the absorption of chlorine by charcoal revealed considerable variations in the capacity of a single sample of charcoal, for which no cause was apparent except variations in the humidity of the chlorine-laden gas. It therefore seemed worth while to make a careful study of the effect obtained with a number of different kinds of charcoal by varying the humidity while controlling the temperature of the charcoal tube. The results of this work were so interesting that the effect of variations of temperature, of velocity of gases through the charcoal, of charcoal thickness and of gas pressure on the surface of the charcoal were also studied.

II. Description of Apparatus.

1. **For the Removal of Chlorine from Air (Dynamic Method).**—This consisted essentially of a charcoal reaction-chamber L, Fig. 1, suspended in a water thermostat. Chlorine from the cylinder X and air entering at A were mixed in the tower J, after which they passed through a layer of charcoal in L. Gases not absorbed were drawn by the suction V through an absorption train, either T₁ or T₂. In order that the apparatus for the thermostat could be handled conveniently, it was suspended from a shelf so constructed that it served as a cover to the bath. The latter consisted of a square copper box resting on a vertically sliding shelf attached by means of overhead pulleys to counter weights. When it was necessary to replace the charcoal charge or manipulate the apparatus, ordinarily in the water, it was necessary only to lower the bath (see dotted line), after which the various parts were easily accessible. To secure uniform and effective circulation, as well as more constant temperature, a wooden compartment O was constructed within and fastened to the copper bath. The perforated lid of the inner box was attached to the cover of the outer copper bath.

In the diagrammatic cut of the heating system, S_p is a switch for starting the motor and stirrer P; L_p is a lamp resistance to regulate the speed of the motor; S_r is a switch to the heating system; I_r is a lamp resistance to conduct the right current for the safe manipulation of the relay R; T is the mercury *thermoscope*; H is the "make and break" on the relay

¹ The writers wish to express their appreciation of the hearty coöperation and helpful criticism given them in the course of the work by Lieut. Col. A. B. Lamb of the Chemical Warfare Service.

and L_h shows the heating lamps which in practice consist of 1" \times 12" show case lights located in the 4 corners of the outer thermostat bath.

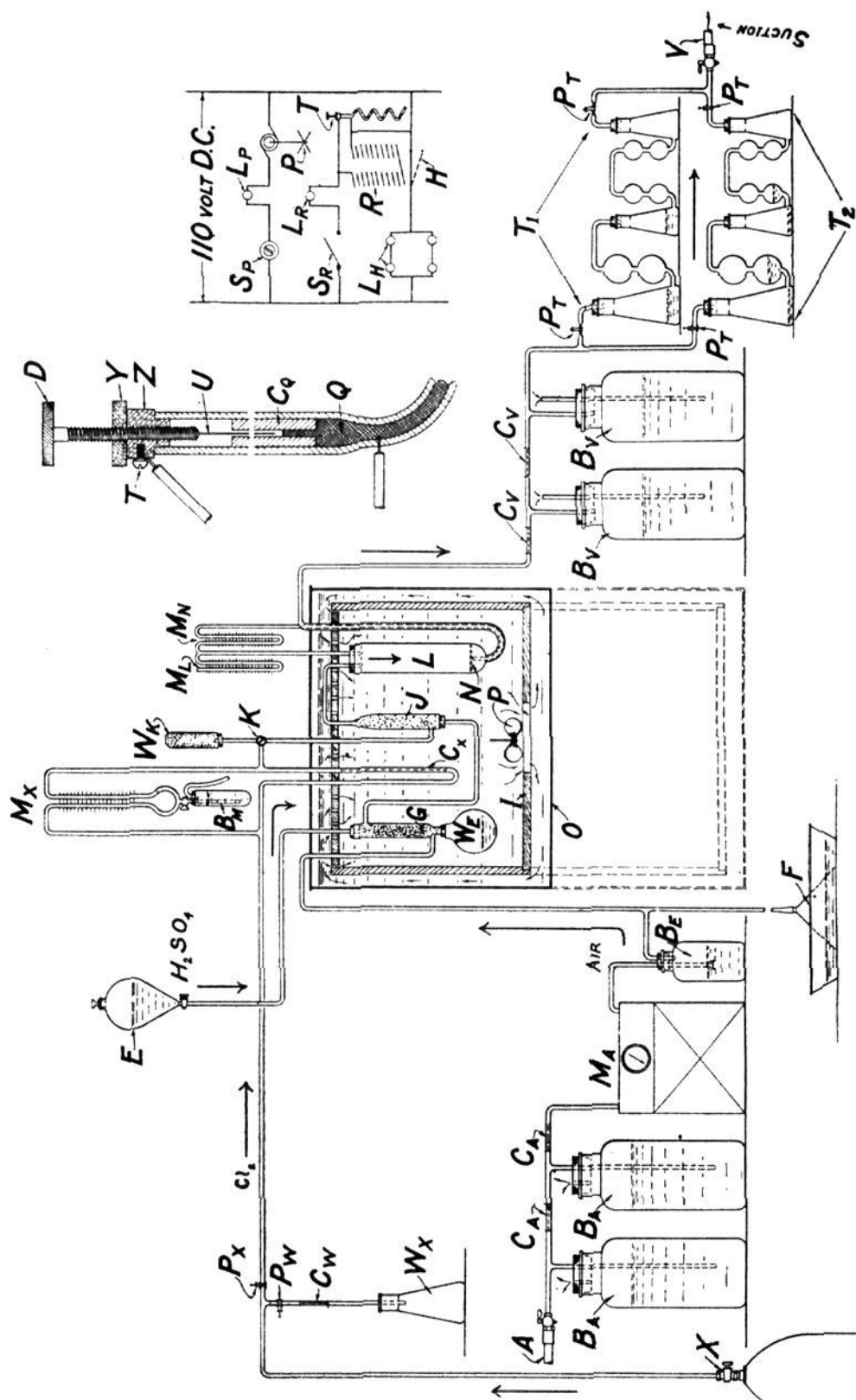

Fig. 1.

In the enlarged cut of the *thermoscope*, D is a thumb screw for adjusting the elevation of the platinum contact U; Y is a lock nut; the brass cap Z

serves as a bearing for the thumb screw D, and as a cover for the spiral glass tube filled with mercury, Q. T is one of the electrical connections.

The quantity of chlorine from the reservoir was measured with a flow-meter M_x so constructed that the capillary C_x was located in the thermostat. Pentachloro-ethane¹ for the manometer was stored in a reservoir B_m , from which, when needed, it was forced into the graduated tube by opening the stopcock and blowing in the open side tube.

After a rough adjustment of the chlorine flow had been made at X the necessary refinement required to keep the flow meter manometer within 0.2 mm. of the correct reading, was made by the use of pinch-cocks P_w and P_x . The capillary tube C_x was so chosen that the manometer reading was always in the neighborhood of 10 cm. To correct for the density change of pentachloro-ethane with temperature, 0.08% per degree was either added or subtracted as conditions required. Daily replacement of the manometer liquid prevented the solution in it of any considerable amount of chlorine.²

While the flow of chlorine was being adjusted at the beginning of an experiment, that gas was diverted to the soda-lime tube W_k by the 2-way stopcock K. During the experiment proper, chlorine flowed through K into the chamber J where with the assistance of glass wool it was mixed with air which entered at the bottom of the same device.

Air under pressure was supplied at the valve A. By allowing an excess of air to bubble at all times from the tubes in the pressure regulating bottles, B_a , variations in the line air pressure were prevented from reaching the gas meter M_a . The air velocity was determined by the depth of the tubes below the water surface in the pressure regulators B_a . To control the moisture content of the air, two separate saturators were employed, each containing sulfuric acid of the strength necessary to produce the desired humidity. By bubbling the air through the first of these, B_e , a moisture content approximating that desired was obtained. To complete the saturation, the air next passed up through the tower G (located in the thermostat) which was filled with glass beads over which flowed more of the same acid. This latter was furnished from the reservoir E and collected in the flask W_e .

To prevent vibrations attending the bubbling of air through B_e from interfering with the readings of the manometers M_x , M_l and M_n , a broad funnel F inverted in a pan of water furnished an effective cushion.³

¹ This compound was prepared from trichloro-ethylene by passing chlorine through the boiling liquid in the presence of iron filings.

² Failure to do this occasionally resulted in the formation of chlorine gas bubbles when the laboratory temperature rose suddenly.

³ This arrangement gives a cushioning effect out of all proportion to the size of the device, in this case equivalent to that of an air reservoir of about 0.54 cu. meter capacity; with a sufficiently large pan, equivalent to that of a closed air cylinder with a cross section equal to that of the water level in the funnel and 32 feet high (the barometric height of water).

The air-chlorine mixture from J entered the top of the reaction chamber L, where it encountered the charcoal resting on a perforated porcelain plate.

To measure the pressure on the upper surface of the charcoal and the drop in pressure experienced by the gas while passing through the absorbent, manometers M_1 and M_2 were employed. The lower manometer connection extended through the exit tube of the charcoal chamber clear into the space N below the charcoal.

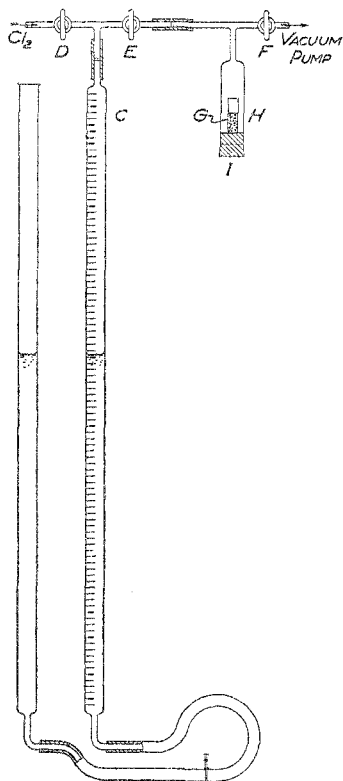

Fig. 2.

chlorine to enter H and volume readings were taken at frequent intervals thereafter.

III. Analytical Procedure.

To determine, in the dynamic method, the time at which chlorine first appeared beyond the charcoal, the escaping gas stream was led through one of the absorption trains, filled with a potassium iodide solution containing starch, Fig. 1. After the blue color had appeared, quantitative results were obtained by diverting the gas mixture to the other absorption train, containing potassium iodide solution without starch, for definite lengths of time. The point at which hydrochloric acid (resulting from the cata-

¹ Usually about 2 mm.

lytic action of the charcoal) first appeared, was determined by backward graphical extrapolation of the acid titer.¹

In samples containing both iodine and hydrochloric acid, the iodine was titrated first with sodium thiosulfate, using starch; the hydrochloric acid was then titrated with sodium hydroxide, using "brom-cresol purple" as indicator.² To prevent carbon dioxide from interfering with the end point, as soon as a fugitive pink color indicated that the titration was nearly finished, air freed from carbon dioxide by soda lime was bubbled through the solution for 2 minutes, after which the neutralization was completed.

It will be noted that no attempt has been made to distinguish between chlorine and any other substance capable of liberating iodine from potassium iodide solution.

IV. Preparation and Properties of Charcoals Used.

With the exception of A the 6 charcoals employed in this work were prepared for use in gas masks and were made from coconut shells. Lot A, for the sake of comparison, was made from ordinary wood and was not manufactured with the object of absorption in view.

V. Analysis of the Typical Chlorine-Charcoal Transmission Curve.

Fig. 3 is drawn to bring out the various factors which influence the shape of the typical charcoal-chlorine transmission curve.

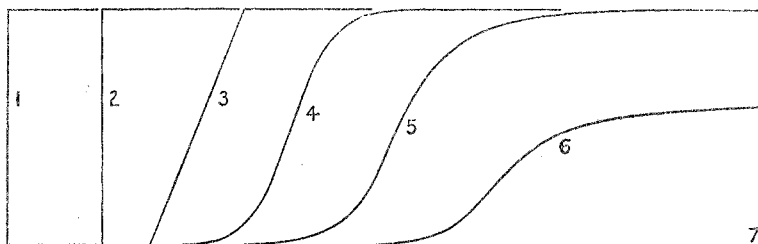

Fig. 3.—Different possible types of transmission curves.

1. Line 1 represents the limit approached by the chlorine-transmission curve as the effectiveness of the absorbing³ material diminishes. Chlorine appears beyond the charcoal in full concentration at once.

2. An ideal⁴ charcoal, infinitely fine-grained and reacting instantaneously

¹ In several of the later experiments the same method was used for the chlorine.

² "Brom-cresol purple" is dibromo-*o*-cresol-sulphonphthalein. Lubs and Clark, *J. Wash. Acad. Sci.*, 6, 482 (1916); *J. Bacteriol.*, 2, 1-34, 109-136, 191-236 (1917). For the method cf. Lewis, Adams and Lanman, *THIS JOURNAL* 37, 2656 (1915).

³ Since it has not been found possible in this work to distinguish between absorption and adsorption, or even chemical action, the word "absorption" will be used throughout this paper, unless otherwise indicated, as a general term comprising all three.

⁴ Any capacity for chlorine which remains unused at the time when toxic amounts of chlorine are being transmitted is wasted, so far as concerns practical use of the charcoal. In the ideal case this residual capacity will, therefore, be reduced to a minimum.

with chlorine, would give a curve of Type 2. The length of the lower horizontal portion represents the absorption capacity of the charcoal.

3. Such a charcoal in a rectangular container, with the thickness varying uniformly from one side to the other, would give a transmission curve of Type 3.

4. The cases just considered have assumed that the absorption reaction is instantaneous. If this assumption be not made, it becomes necessary to make some assumption for the rate of reaction, and the simplest probable one is that the rate of the reaction is proportional to the fraction of its capacity which the charcoal still retains, and to the concentration of chlorine in the gas. This amounts to assuming that the reaction is monomolecular with respect to chlorine (which is probably true) and that the charcoal is perfectly uniform in respect to its rate of absorbing chlorine (which is certainly not exactly so).

Derivation of Equation for Line 4.—Let c represent the concentration of chlorine at any distance, x , a the residual chlorine capacity of the charcoal and v the rate of supply of chlorine expressed in cm. of charcoal saturated per hour in the event of complete reaction. The rate of the absorption reaction is $k \times c \times a$.

Considering a given portion of absorbing material, its residual capacity is diminishing at the rate given by:

$$\frac{\partial a}{\partial t} = -kac \quad (1)$$

Considering a given portion of air, its chlorine content is diminishing at the rate given by the equation

$$\frac{\partial c}{\partial x} = \frac{-k}{v} ac. \quad (2)$$

From this the following equations can be obtained, in which $a' = a/a_0$, $c' = c/c_0$, $x'' = 0.4343 ka_0 x/v$ and $t'' = 0.4343 kc_0 t$. (The derivation will be found in an appendix.)

$$c' = \frac{10^{t''}}{10^{x''} - 1 + 10^{t''}} \quad (23)$$

$$a' = \frac{10^{x''}}{10^{x''} - 1 + 10^{t''}}. \quad (24)$$

Except for very small values of both x'' and t'' , the middle term in the denominators is entirely negligible and the equations become:

$$c' = \frac{1}{10^{x''-t''} + 1}$$

$$a' = 1 - c'$$

Line 4 of Fig. 3 represents the relation between concentration and time, as given by the first of these equations.

It should be noted that other causes will tend to "round off" the angles in the curve, notably reversibility of the absorption reaction and inhomogeneity of composition or packing of the charcoal.

5. Line 4 is a *symmetrical* curve with its point of inflection at 50% transmission. If, however, the rate of absorption falls off more rapidly than the residual capacity of the charcoal, as will be the case if the charcoal consists of 2 or more constituents of unequal reactivity, an unsymmetrical curve will be obtained. This is illustrated by Line 5.

6. In all these cases it has been assumed that the action is entirely between the charcoal and the chlorine. If, however, the charcoal acts as a catalyst¹ for reactions between the chlorine and (for example) water vapor, the transmission will reach a value lower than 100% when the chloride capacity of the charcoal has been exhausted; and if the rate of catalysis is great enough in proportion to the rate at which chlorine is being supplied, no chlorine will be transmitted, however long the experiment be continued. These cases are represented by Lines 6 and 7.

VI. Results Obtained by the Dynamic Method and the Effect of Different Variables on the Transmissions.

The reproducibility of the results is shown in Fig. 4, which represents 2 typical experiments in which both chlorine and hydrogen chloride were determined in the effluent gas. The variations are seen to be slight. They probably resulted chiefly from irregularities in packing of the charcoal in the chamber. Unfortunately, the importance of this factor was not fully realized until a large part of the work given in this paper had been done.

The effect of different variables on the transmission of chlorine and of hydrogen chloride is as follows.

1. **Kind of Charcoal.**—The strikingly great variation in absorption which is exhibited by different charcoals is illustrated in Fig. 5, showing the transmission curves of 4 different charcoals, where Specimen D is seen to have had a service time approximately 400 times that of A.

The general similarity in form of the curves suggests the process involved to be qualitatively the same for all, and the service times of various charcoals may depend more upon variations in the proportions of active to relatively inactive constituents in each than to differences between the materials as a whole.

Although the apparent densities of these charcoals vary considerably, the service times vary still more, and their order with respect to apparent density is not the same as that with respect to service time.

¹ As it is not certain whether the charcoal is permanently altered, the word "catalysis" has been used throughout this paper to include any action involving chlorine, water and charcoal and yielding hydrogen chloride (cf. Bancroft, *J. Phys. Chem.*

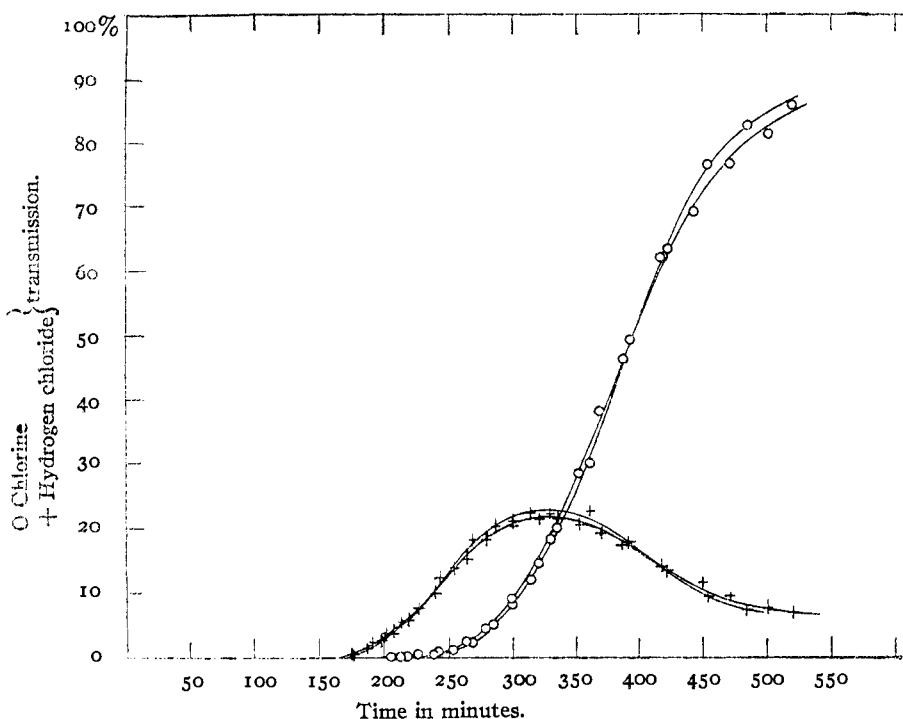

Fig. 4.

Transmission curves of dry chlorine and hydrogen.

Charcoal = E.

Depth of layer = 10 cm.

Cross-section = 10.75 sq. cm.

Weight = 67.0 g.

Mesh = 8-10.

Temperature = 25.0°.

Velocity of gas = 500 cm./min.

Air-chlorine ratio = 500-1.

Water content of air = 0.

Pressure of gas above charcoal = 1 atmosphere.

From a consideration of the service time of the specimens plotted in Figs. 5 and 7, which follow, it becomes evident that variations between the activities of any 2 charcoals is greater than that which would result from any reasonable variation in the humidity of the gas stream.

2. Depth of Layer.—When the layer is very thin, constituents of charcoal having a low reaction velocity do not have a marked influence on the shape of the chlorine transmission curve. As the thickness increases, however, the time factor operates to increase the importance of the less active material in the sense that doubling the depth of absorbent layer more than doubles the time required for either the front of the chlorine wave or a layer of given chlorine concentration to reach a proportional point in the charcoal column. Chlorine transmissions of the same charcoal with depths, 1, 2, 5, and 10 cm., respectively, are given in

Fig. 6. It seems probable that the increasing slant of these curves as the depth of layer becomes greater is a consequence of the peculiar effect of relatively inactive constituents discussed above.

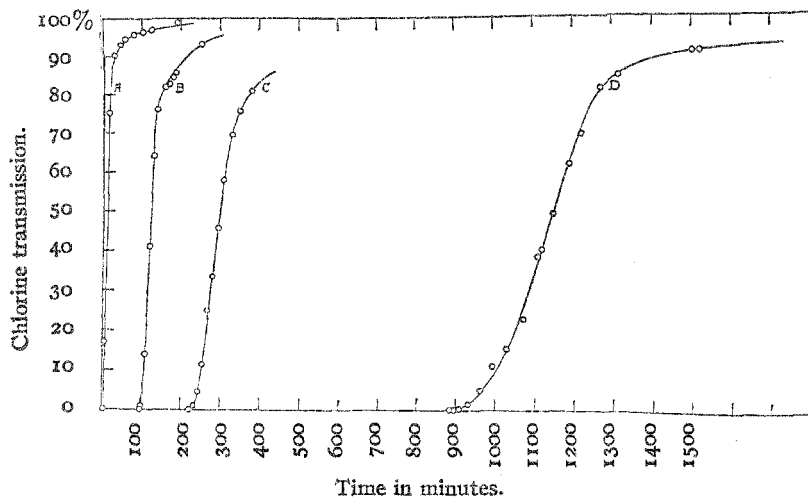

Fig. 5.

Transmission curves of charcoal, A, B, C and D, with dry chlorine-air mixture.

Charcoals = A, B, C and D.

Temperature = 25.0°.

Depth of layer = 10 cm.

Velocity of gas = 250 cm./min.

Cross-section = 10.75 sq. cm.

Air-chlorine ratio = 1000-1.

Weights: A = 23 g.; B = 77 g.; C = 77 g.;

Water content of air = 0.

D = 66 g.

Pressure of gas above charcoal = 1 atmosphere.

Mesh = 20-40.

3. **Water Content of the Gas Mixture.**—The extent to which chlorine was consumed by chemical action yielding hydrogen chloride was not appreciated in the earlier part of the investigation. Its great importance can be seen from Fig. 7, in which the transmission curves both for chlorine and hydrogen chloride at different humidities are shown.

The efficiency of the charcoals as catalysts for the reaction between water and chlorine and the capacity of charcoals for chlorine absorption have been found to be approximately proportional. Charcoal E, Fig. 7, which was employed in the study of the effect of gas humidity differences, had a high chlorine capacity and, therefore, was well suited to a study of catalysis.

It will be seen from the results of hydrogen chloride titrations given, that for humidity values up to 40% the courses of the reactions during the first 375 minutes were approximately the same. After this time, however, the magnitude of the catalysis was considerably dependent upon the supply of incoming moisture. This charcoal was not dried before

the experiments were begun and was probably in equilibrium with atmospheric humidity of at least 40%. The results obtained suggest that, in the absence of liquid phase, adsorbed water alone played an important part in the catalysis and if any assistance was rendered by moisture from the gas stream taking the place of that used up in the reaction, its effect was slight until after about 325 minutes. From this time on, water supplied by the gas mixture did assist the catalysis to an extent proportional to the water concentration. This is indicated by the relative positions of the hydrogen chloride curves from 500 minutes on.

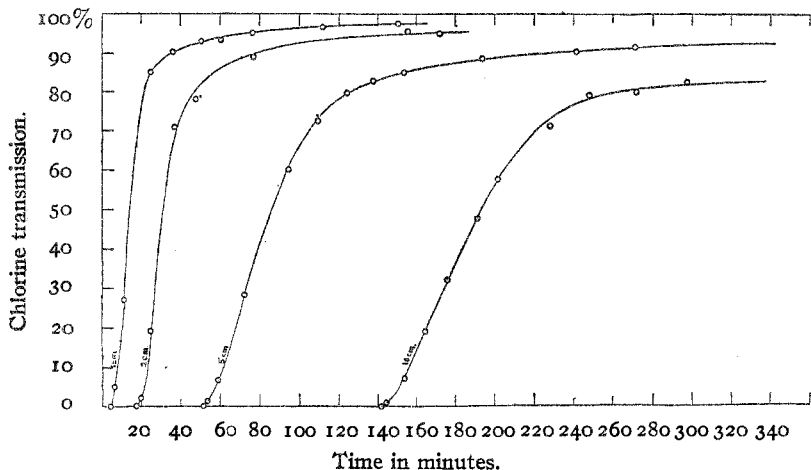

Fig. 6.

Transmission of chlorine through different depths of absorbent.

Charcoal = B.

Depth of layer = 1, 2, 5 and 10 cm.

Cross-section = 10.75 sq. cm.

Weight = 7.7, 15.4, 38.5 and 77.0 g.

Mesh = 20-40.

Temperature = 25.0°.

Air-chlorine ratio = 1000-1.

Velocity of gas = 250 cm./min.

Water content of air = 80.0% saturation.

Pressure of gas above charcoal = 1 atmosphere.

Pressure of gas below charcoal = 1 atmosphere — 0.42, 0.69, 1.56 and 2.60 cm. H₂O.

At a humidity value somewhere between 40 and 80% the affinity of adsorbed hydrogen chloride for water probably precipitated the liquid phase and this greater concentration of the water accelerated the catalysis for a certain length of time.

The late appearance of hydrogen chloride beyond the charcoal when the liquid phase was present may be attributed to the probability that the capacity of the system for hydrogen chloride was increased by the solvent action of the liquid present. The collection, in this experiment, of a strong aqueous hydrogen chloride solution at the elbow below the charcoal column as well as a distinctly wet appearance of the charcoal

itself left no doubt of the actual existence of the liquid phase. For humidity values of 50% or less no liquid was ever noticed on the charcoal surface.

It will be shown later that the capacity of Charcoal D for chlorine, leaving catalysis out of account, was increased by previous drying of the absorbent. With Charcoal E the consumption of chlorine through catalysis was not, in the earlier part of the experiments, increased by humidity

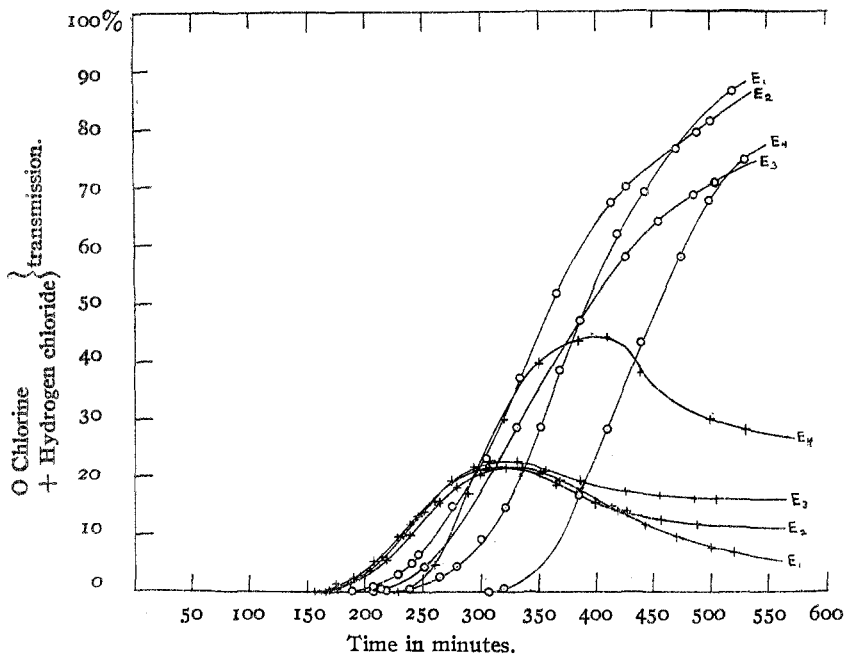

Fig. 7.

Transmission curves of chlorine and hydrogen chloride at different humidities.

Charcoal = E.

Depth of layer = 10 cm.

Cross-section = 10.75 sq. cm.

Weight = 67.0 g.

Mesh = 8-10.

Temperature = 25.0°.

Velocity of gas = 500 cm./min.

Air-chlorine ratio = 500-1.

Water content of air: E₁ = 0.0% saturation; E₂ = 20.0% saturation; E₃ = 40.0% saturation; E₄ = 80.0% saturation.

Pressure of gas above charcoal = 1 atmosphere.

values of either 20 or 40%, hence the service time of the charcoal in the gas containing those moisture concentrations was less than when dry air was used, for in the last-named case the absorbent was automatically dried. Soon after the chlorine "break," however, the moisture in the gas mixture did assist catalysis to such an extent that the chlorine titrations were relatively lower than when dry air was used, and this is re-

flected in the curves by an increasingly lower slant as the humidity concentrations go up.

At a humidity value somewhere between 40 and 80% catalysis became so great, even in the earlier part of the experiment, that it operated to lengthen the service time of the charcoal above that realized with the use of dry air. The above results indicate that a minimum service time for chlorine absorption would occur when humidity values were somewhere between 20 and 80%.¹

When the humidity was 80% the chlorine "break" was delayed but the slant of the chlorine absorption curve was steeper than for lower humidity

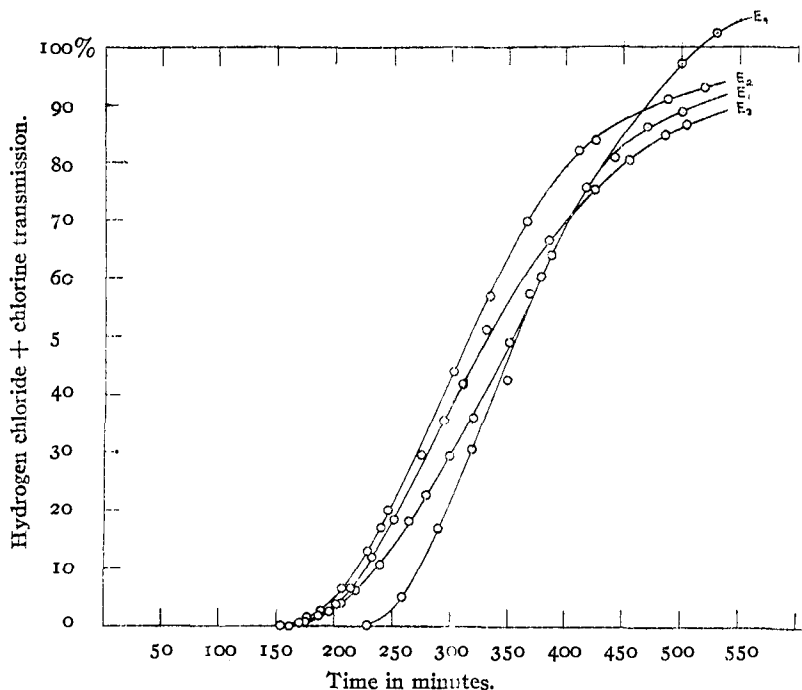

Fig. 8.

Summation curves of chlorine and hydrogen chloride transmission at different humidities.

Charcoal = E.

Depth of layer = 10 cm.

Cross-section = 10.75 sq. cm.

Weight = 67.0 g.

Mesh = 8-10.

Temperature = 25.0°.

Velocity of gas = 500 cm./min.

Air-chlorine ratio = 500-1.

Water content of air: E₁ = 0.0% saturation; E₂ = 20.0% saturation; E₃ = 40.0% saturation; E₄ = 80.0% saturation.

Pressure of gas above charcoal = 1 atmosphere.

¹ The properties of different charcoals exhibit a wide variation so this statement is intended to apply to this particular specimen only.

values. This effect, peculiar to the 80% humidity experiment, is a direct consequence of the relatively more rapid decline¹ in the extent of catalysis during the time from 400 minutes onward.

The results in Fig. 8 show the sum of the transmission values of chlorine, both combined and elementary, as given in Fig. 7. For humidity values of 0, 20 and 40%, represented by E_1 , E_2 and E_3 , respectively, no pronounced differences exist. The presence of a liquid phase when 80% humidity was employed provided a reservoir for hydrogen chloride, supplying that compound to the gas stream at a rate diminishing more slowly than the rate of chlorine transmission increased. For this reason the chlorine, elementary and combined, transmitted by the charcoal, amounted at one time to more than that which entered the apparatus.

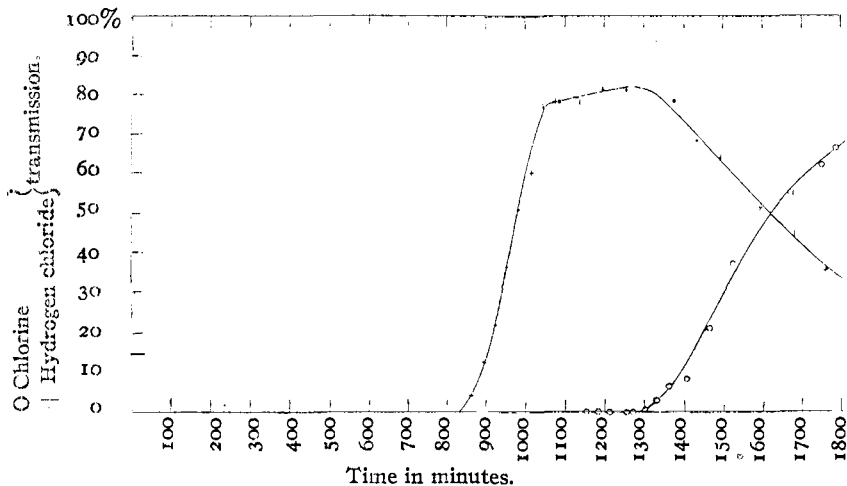

Fig. 9.

Transmission curves of chlorine and hydrogen chloride at 50% humidity and low rate of flow.

Charcoal = D.

Depth of layer = 10 cm.

Cross-section = 10.75 sq. cm.

Weight = 66.0 g.

Mesh = 20-40.

Temperature = 25.0°.

Velocity of gas = 250 cm./min.

Air-chlorine ratio = 1000-1.

Water content of air = 50.0% saturation.

Pressure of gas above charcoal = 1 atmosphere.

Pressure of gas below charcoal = 1 atmosphere less 2.66 cm. H₂O.

Fig. 9 shows the transmission curves of chlorine and hydrogen chloride at 50% humidity at low rates of flow. Since the experimental conditions were very different from those in the humidity experiments described above, the results are not readily comparable but are illumina-

¹ To what extent this rapid decline resulted from choking of the capillary spaces by liquid can only be conjectured, but the catalytic surface was no doubt somewhat reduced thereby.

ting. Since the lower velocity, here, of both the air and chlorine, eliminated to some extent the crowding of successive events which occurred with the higher gas velocity and chlorine concentration. This makes an analysis and interpretation of the results more easily accomplished.

During the progress of chlorine absorption by the dynamic method a relatively thin heated section travels down along the charcoal column and arrives at the bottom nearly simultaneously with the first appearance of chlorine. In the earlier experiments without a thermostat, the tube was warm to the touch for perhaps a centimeter length and at a depth below the surface of the charcoal proportional to the stage of the experiment.¹ By a consideration of this phenomenon together with the shape of the transmission curves a possible interpretation of the results in Fig. 9 may be deduced as follows:

1. During the first 850 minutes all of the chlorine, as well as the hydrogen chloride, was absorbed and the warm reaction zone had progressed approximately $\frac{4}{5}$ of the length of the charcoal column.²

2. At 850 minutes the charcoal was no longer able to hold all the hydrogen chloride produced and that compound appeared in greater and greater amounts during the next 200 minutes.

3. At about 1050 minutes the charcoal had become practically saturated with respect to hydrogen chloride and from that time on for 200 minutes all of the hydrogen chloride produced and a trace of chlorine escaped.

4. After about 1300 minutes had passed, the lower edge of the active reaction zone reached the lower end of the charcoal column and as the thickness of the former became less the importance of catalysis diminished and the concentration of chlorine in the effluent gas necessarily increased.

The fact that, from 1300 minutes on, the decrease in rate of hydrogen chloride transmission balanced the increase in rate of chlorine transmission indicates catalysis amounting to practically 100% of absorbed chlorine, both before and after the appearance of chlorine beyond the charcoal. The increase in rate of chlorine supply soon places a limit beyond which complete catalysis does not occur. This is illustrated by the pronounced break in the transmission curve, Fig. 13. Here the rate of chlorine supply was 4 times that in the experiment under consideration.

5. Temperature.—As is generally recognized, the capacity of char-

¹ It was obviously impossible to observe, and *a fortiori* to measure this effect when the thermostat was employed.

² The rate of movement of the rapid reaction zone down the charcoal column was probably progressively slower as time went on because a certain amount of chlorine was always being sluggishly absorbed by the charcoal in the wake of the more rapid reaction layer and the quantity of this relatively inactive material increased progressively.

coals for gases decreases as the temperature is elevated, since ordinary absorption is a reversible reaction. When water is present in an air-chlorine mixture, however, this behavior is somewhat modified because higher temperatures (within the range studied) favor the catalytic reaction¹ in which charcoal assists the interaction of chlorine and water with the formation of hydrogen chloride and oxygen. Other chlorine compounds may also have been produced but they were not detected in the exhaust gas stream.

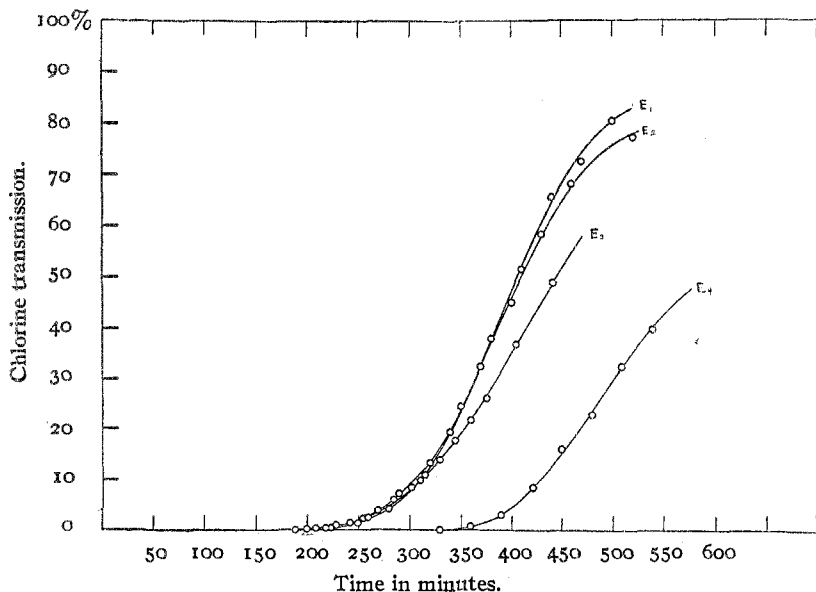

Fig. 10.

Transmission curves of chlorine at different temperatures.

Charcoal = E.

Depth of layer = 10 cm.

Cross-section = 10.75 sq. cm.

Weight = 67 g.

Mesh = 8-10.

Temperature: E₁ = 0.0°; E₂ = 12.5°; E₃ = 25.0°; E₄ = 37.5°.

Velocity of gas = 500 cm./min.

Air-chlorine ratio = 500-1.

Water content of air = 50.0% saturation.

Pressure of gas above charcoal = 1 atmosphere.

Pressure of gas below charcoal = 1 atmosphere less 0.85 cm. H₂O.

¹ By passing a rapid stream of chlorine, together with an excess of steam and a small amount of air, over charcoal enveloped in a steam bath, all of the chlorine was apparently converted to hydrogen chloride for a long period of time. The water insoluble gas evolved contained a high proportion of carbon dioxide.

It is known that charcoals prepared under special conditions are often so susceptible to oxidation that they even catch fire spontaneously in air. Possibly the consumption of that portion of chlorine which appears as hydrogen chloride beyond the charcoal may be largely due to a reaction in which carbon is oxidized to carbon dioxide, the oxygen being furnished by hypochlorous acid or other oxidizing agent containing hydrogen, oxygen, and chlorine, the reduction of which yields hydrogen chloride.

Fig. 10 shows the effect of temperature on chlorine transmission. Within the temperature range studied it will be seen that the effect of equal increments of temperature is irregular. Two conflicting tendencies operate to determine the service time and the progress of absorption after the chlorine "break." The absorption capacity of the charcoal is lowered by a rise in temperature but catalysis, on the other hand, is at the same time assisted thereby. With respect to service time, the resultant of these opposing tendencies is nearly identical for the temperature range 0.0° to 12.5° . After the transmission value has reached the neighborhood of 40%, the escape of chlorine with temperature rise becomes progressively less for all temperatures used. The interval 25.0° to 37.5° is marked by a pronounced change in the service time of the charcoal with respect to chlorine.

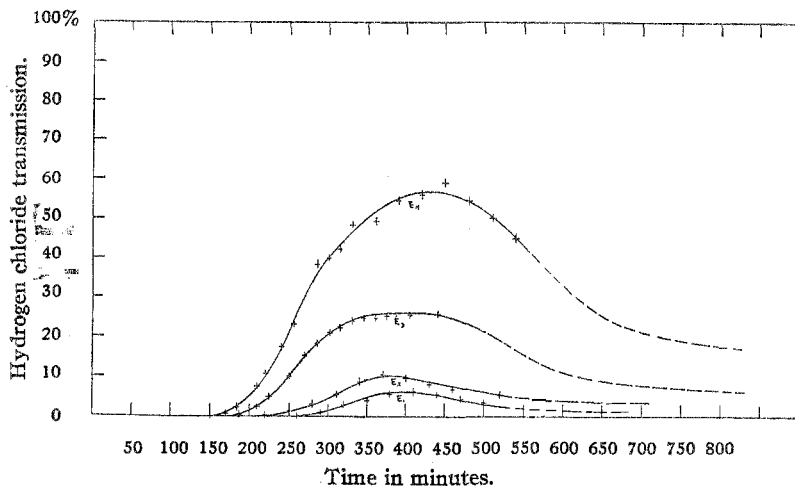

Fig. 11.

Charcoal = E.

Depth of layer = 10 cm.

Cross-section = 10.75 sq. cm.

Weight = 67.0 g.

Mesh = 8-10.

Temperature: $E_1 = 0.0^{\circ}$; $E_2 = 12.0^{\circ}$; $E_3 = 25.0^{\circ}$; $E_4 = 37.5^{\circ}$.

Velocity of gas = 500 cm./min.

Air-chlorine ratio = 500-1.

Water content of air = 50.0% saturation.

Pressure of gas above charcoal = 1 atmosphere.

Pressure of gas below charcoal = 1 atmosphere less 0.85 cm. H₂O.

Fig. 11 shows the effect of temperature on the transmission of hydrogen chloride. The transmission of hydrogen chloride as affected by the temperature is dependent upon 2 factors: catalysis, which increases the total quantity of that acid; and evaporation which reduces the amount of hydrogen chloride retained by the charcoal. The results of the hydrogen chloride titrations, Fig. 11, represent the resultants of these 2 effects, and the areas inclosed between the various curves, up to a given time,

measure in each case the differences in transmission. For instance, up to 450 minutes the ratio for the intervals 0.0° to 12.5° : 12.5° to 25.0° : 25.0° to 37.5° was about 1 : 5 : 8.

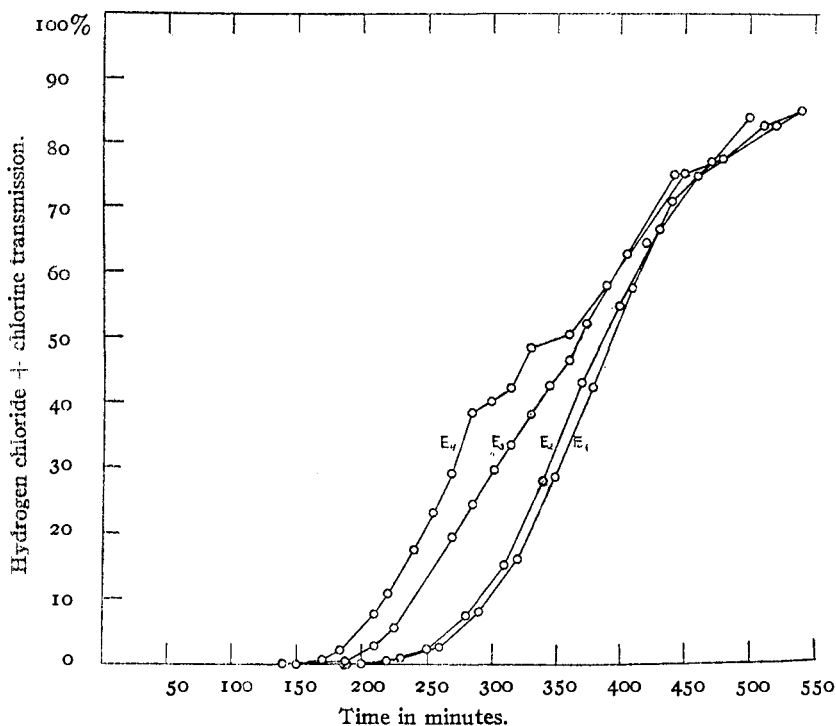

Fig. 12.

Transmission curves of chlorine and hydrogen chloride combined.

Charcoal = E.

Depth of layer = 10 cm.

Cross-section = 10.75 sq. cm.

Weight = 67.0 g.

Mesh = 8-10.

Temperature: $E_1 = 0.0^{\circ}$; $E_2 = 12.5^{\circ}$; $E_3 = 25.0^{\circ}$; $E_4 = 37.5^{\circ}$.

Velocity of gas = 500 cm./min.

Air-chlorine ratio = 500-1.

Water content of air = 50.0% saturation.

Pressure of gas above charcoal = 1 atmosphere.

Pressure of gas below charcoal = 1 atmosphere less 0.85 cm. H_2O . (Mean value.)

Fig. 12 depicts the relation between temperature and the transmission of chlorine and hydrogen chloride combined. Evidently temperature has surprisingly little effect on this combined transmission. To reach the 2 points, "break" and 70% total transmission, the time required is almost identical in the temperature range studied. The greatest temperature effect is to be seen at about 20% transmission and, as was to be expected, the greatest transmission, at a given time from the beginning of the experiment, occurred with the highest temperature, and so on down the scale.

Under the particular conditions of charcoal depth and chlorine flow employed in this work it was found that chlorine and hydrogen chloride (Figs. 10 and 11) appeared beyond the absorbent simultaneously when the temperature was in the neighborhood of 12.5° . Chlorine appeared sooner than hydrogen chloride below 12.5° and the order was reversed above that temperature. The apparently high temperature coefficient of charcoal for hydrogen chloride absorption probably results largely from the effect of temperature on the magnitude of charcoal catalysis whereby chlorine reacts with water, forming hydrogen chloride.

6. Pressure.—The absorption of chlorine and the catalysis of chlorine and water by charcoal were investigated at reductions of pressure of 30 and 60 cm. of water, respectively, and also at atmospheric pressure. The results in all 3 cases were found to be so similar that the slight variations which did occur may have been within the limit of experimental error. If anything, the reduction in pressure increased the efficiency of the charcoal for the removal of chlorine from the gas stream.

7. Interruption During the Course of Experiment.—Fig. 13 clearly demonstrates the effect of a period of rest on charcoal which has been saturated with chlorine and hydrogen chloride in the presence of moisture. In a 12-hour interval which elapsed between the end of the first

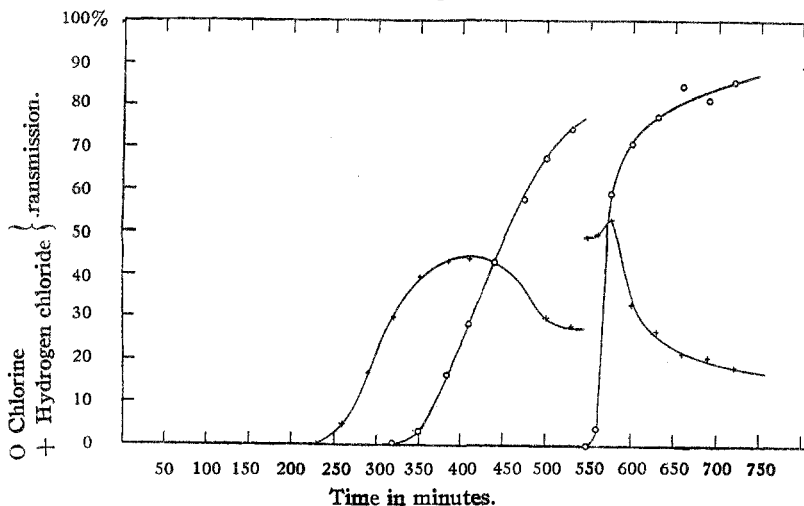

Fig. 13.

Charcoal = E.

Depth of layer = 10 cm.

Cross-section = 10.75 sq. cm.

Weight = 67.0 g.

Mesh = 8-10.

Temperature = 25.0°

Velocity of gas = 500 cm./min.

Air-chlorine ratio = 500-1.

Water content of air = 80.0% saturation.

Pressure of gas above charcoal = 1 atmosphere.

Pressure of gas below charcoal = 1 atmosphere less 0.91 cm. H_2O .

545 minute period and the resumption of the experiment all of the chlorine had either reacted with water to form hydrogen chloride or become so firmly attached to the charcoal that it could not be dislodged by the air stream. The former seems the more plausible reason for the observed phenomenon, because the quantity of hydrogen chloride transmission immediately after the intermission was usually large. The capacity of the absorbent for chlorine had not revived very much, however. This may have been due to the fact that the available secondary valence forces (or whatever the forces are which cause absorption) were largely satisfied by hydrogen chloride, water, and firmly held chlorine. It follows from the assumption that an intermission is accompanied by catalytic conversion of chlorine to hydrogen chloride that a reduction in the rate of chlorine flow would result in a larger proportion of the entering chlorine being converted to hydrogen chloride or other chlorine compounds; at least if the catalytic efficiency of the charcoal were not impaired.¹

VII. Data Obtained by the Static Method.

Fig. 14 represents transmission curves of 4 charcoals where time is plotted against chlorine absorption per g. of charcoal. The differences between B, C and D seem to be of degree rather than of kind, whereas

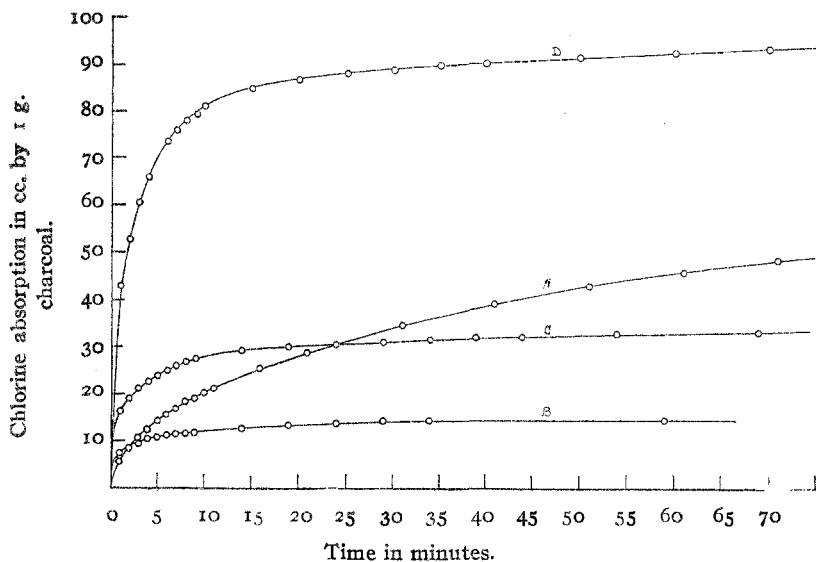

Fig. 14.

Charcoals = A, B, C and D. Mesh = 10-20. Temperature = 24.0°.

¹ Reducing the rate of chlorine flow not only automatically increases the ratio of water to chlorine—the rate of air flow remaining constant—but it also approaches the state of rest under which conditions all uncombined chlorine has been shown to react to form hydrogen chloride or other chlorine compounds.

the nature of Curve A suggests that charcoal to be of an entirely different type. This is to be expected from the data given in Section IV above.

VIII. Revivification by Heating in Vacuo.

The chlorine capacity of Charcoal D¹ was increased by one exposure to chlorine followed by heating to dull redness *in vacuo* (see D_a and D_b, Fig. 15). This was at least partly due to the fact that before the first exposure to pure chlorine, places to which this gas would otherwise have been fastened were already occupied by other chemical individuals.

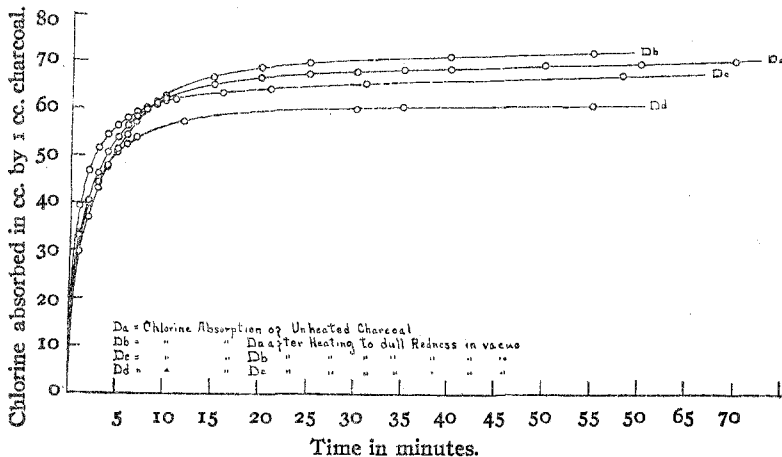

Fig. 15.

Charcoal = D. Mesh = 10-20. Temperature = 24.0°.

That is to say, the absorbing surface was relatively clean with respect to absorbed material at the beginning of the second exposure.

TABLE I.

Change in wt.	From.	To.	%.
Loss.....	D _a	D _b	1.21
Gain.....	D _b	D _c	4.75
Gain.....	D _c	D _d	16.62

It is also possible that chlorine may have formed volatile compounds with certain inactive constituents of the charcoal whose disappearance during later evacuation left a material containing a higher proportion of active absorbent and a material more thoroughly honeycombed by capillary spaces suitable for absorption. The loss in weight shown in Table I at least does not conflict with this hypothesis. 2. This charcoal gained weight after several exposures to chlorine, but this may have resulted from the chlorination or oxidation of carbon complexes with high molecular weight which reacted sluggishly from the standpoint of absorption.

¹ Before the first exposure to chlorine this charcoal was allowed to come to equilibrium with water and other gases in the atmosphere of the laboratory.

3. The curves indicate that after several exposures the chlorine capacity of the charcoal had been slightly reduced but the steep rise during the earlier part of the experiment shows that the activity was not seriously impaired.

IX. Appendix.

Given

$$\frac{\partial c}{\partial x} = -\frac{k}{v} ac \tag{1}$$

$$\frac{\partial a}{\partial t} = -kac. \tag{2}$$

For discussion and definitions, see text immediately preceding Equations 1 and 2 in Section V.

Now, the "boundary conditions" are that the charcoal has initially a uniform volume chlorine capacity, which we will call a_0 , and that the air entering the charcoal has a constant chlorine concentration, which we will call c_0 .

Let

$$a' = a/a_0, \quad c' = c/c_0, \quad x' = ka_0x/v, \quad t' = kc_0t.$$

Then:

$$\frac{\partial c'}{\partial x'} = -a'c' \quad \frac{\partial a'}{\partial t'} = -a'c', \tag{3} \tag{4}$$

Or

$$\frac{\partial \ln c'}{\partial x'} = -a' \quad \frac{\partial \ln a'}{\partial t'} = -c'. \tag{5} \tag{6}$$

When $t' = 0$, $a' = 1$, and (5) integrates to

$$c' = e^{-x'}. \tag{7}$$

Where $x' = 0$, $c' = 1$, and (6) integrates to

$$a' = e^{-t'}. \tag{8}$$

Differentiating (5) and (6)

$$\frac{\partial^2 \ln c'}{\partial t' \partial x'} = -\frac{\partial a'}{\partial t'} = a'c' \quad \frac{\partial^2 \ln a'}{\partial x' \partial t'} = -\frac{\partial c'}{\partial x'} = a'c'. \tag{9} \tag{10}$$

Subtracting (10) from (9)

$$\frac{\partial^2 \ln (c'/a')}{\partial t' \partial x'} = 0 \tag{11}$$

$$\ln (c'/a') = f(x') + f(t'). \tag{12}$$

Imposing boundary conditions this becomes

$$\ln (c'/a') = t' - x' \tag{13}$$

Or

$$c'/a' = e^{t'-x'}.$$

Rewriting (3) and (4)

$$-\frac{\frac{\partial c'}{c'^{12}}}{\partial x'} = \frac{a'}{c'} = e^{x'-t'} \quad -\frac{\frac{\partial a'}{a'^2}}{\partial t'} = \frac{c'}{a'} = e^{t'-x'}. \quad (15) (16)$$

Integrating

$$1/c' = e^{x'-t'} - f(t') \quad 1/a' = e^{t'-x'} - f(x'). \quad (17) (18)$$

Evaluating the constants, from (7) and (8)

$$1/c' = e^{x'-t'} - e^{-t'} + 1 \quad 1/a' = e^{t'-x'} - e^{-x'} + 1, \quad (19) (20)$$

Or

$$c' = \frac{e^{t'}}{e^{x'} - 1 + e^{t'}} \quad a' = \frac{e^{x'}}{e^{x'} - 1 + e^{t'}}. \quad (21) (22)$$

Placing $x'' = 0.4343 x'$ and $t'' = 0.4343 t'$ and changing to common logarithms

$$c' = \frac{10^{t''}}{10^{x''} - 1 + 10^{t''}} \quad a' = \frac{10^{x''}}{10^{x''} - 1 + 10^{t''}}. \quad (23) (24)$$

X. Summary.

1. In the particular series of charcoals here considered the variations in chlorine-absorbing power between any 2 kinds was greater than that which would result from any attainable variation in the humidity of the gas stream.

2. The order of the charcoals with respect to duration of complete chlorine absorption¹ is not the same as that with respect to apparent density.

3. The duration of complete chlorine absorption increases more rapidly than the thickness of the layer of charcoal, other conditions remaining constant.

4. For the charcoals studied the duration of complete chlorine absorption passes through a *minimum* for a relative humidity in the neighborhood of 50%.

5. The duration of complete chlorine absorption is at a *minimum* between 0° and 12.5°.

6. For the charcoals studied, below 12.5° chlorine appeared beyond the charcoal before hydrogen chloride; above 12.5° hydrogen chloride appeared before chlorine.

7. Reductions in pressure up to two feet of water (barometric pressures down to 71 cm. mercury) have little effect.

8. The chlorine capacity of the charcoal studied is increased by one exposure to chlorine followed by heating to dull redness *in vacuo*.

WASHINGTON, D. C.

¹ Referred to above as the "service time" of the charcoal.